

REF. REI: 7-571.33
 SKU: 000571064003307
 EAN: 8423224764534

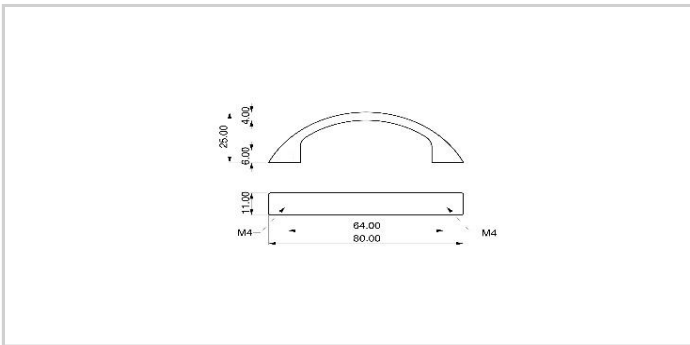

PRODUCTO

material	Zamak
acabado	Cromo Mate
longitud	80 mm.
anchura	11 mm.
altura	24 mm.
peso neto	29 g.
peso bruto	34 g.
medida principal	64 mm.

PACKAGING

longitud envase	90 mm.
anchura envase	120 mm.
altura envase	10 mm.
peso neto	34 g.
peso bruto	35 g.
uds por envase	1

CONDICIONAMIENTO

longitud	134 mm.
anchura	93 mm.
altura	82 mm.
peso bruto	378 g.
volumen	0,001022 m3.
unidades por caja	10